



Opzs Series

BSB Opzs Series Lead Acid batteries are designed with a combination of die-casting Tubular positive framework and superfluous electrolyte technologies to offer a very high lever of reliability and a long service life. Opzs batteries used special filter and proof design to ensure no acid fog runs over and burning proof, and also convenient examine and maintenance.

Application

- | | |
|--------------------|---------------------------|
| Telecommunications | Medical Equipment |
| Cable Television | UPS |
| Electric Utility | Railroad Utility |
| Control Equipment | Photovoltaic System |
| Security System | Alternative Energy System |



General Features

- Maintenance convenient.
- Non-Spillable construction design.
- Transparent containers, convenient to observe.
- Special filter installation for acid fog proof.
- High quality and high reliability.
- Super long service life.
- Special pole sealed technology.
- Super reliability.

Construction

- | | | | |
|-----------------|--------------|-------------------|---------------|
| Component | Raw material | Terminal | Copper |
| Positive | Lead dioxide | Separator | Rubber-PVC |
| Negative | Lead | Electrolyte | Sulfuric acid |
| Container | AS | | |
| Cover | AS | | |

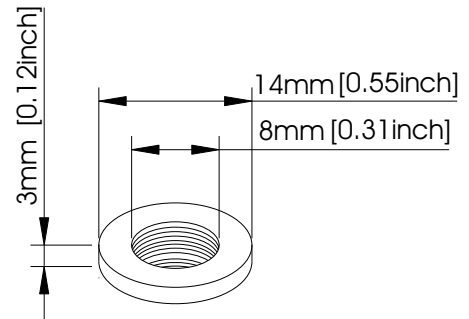

Terminal Dimensions

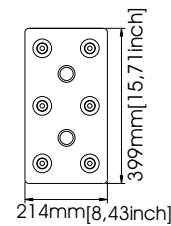
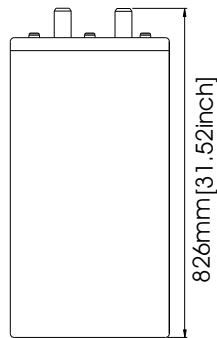

Battery Model	OPzS 2-1875			
Designed Floating Life	15 Years			
Capacity(25°C)	24HR(93.75A,1.85V)	10HR(187.5A,1.80V)	5HR(315A,1.77V)	1HR(930A,1.67V)
	2250AH	1875AH	1575AH	930AH
Dimensions	Length	Width	Height	Total Height
	399mm(15.71inch)	214mm(8.27inch)	771mm(30.35inch)	826mm(31.52inch)
Approx. Weight	Without electrolyte:113 Kg (249.2 lbs)		with electrolyte: 158 Kg (348.4 lbs)	
Internal Resistance	Full charged at 25°C: 0.00055 Ohm			
Self Discharge	3% of capacity declined per month at (25°C)			
Capacity Affected by Temp.(20HR)	40°C	25°C	0°C	-15°C
	102%	100%	85%	65%
Charge Voltage(25°C)	Cycle use		Float use	
	2.35V-2.4V(-5mV/ °C), max. Current: 281A		2.24V(-3.3mV/ °C)	

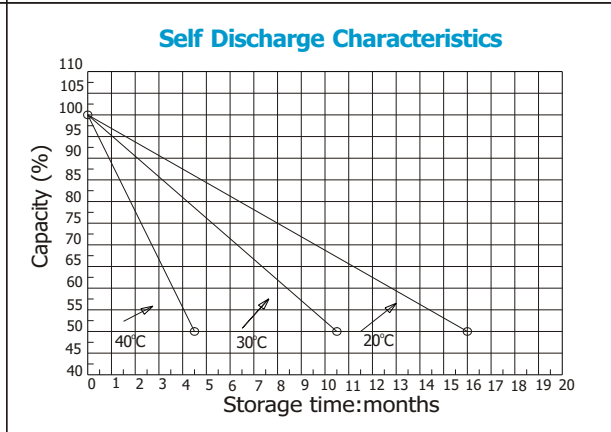
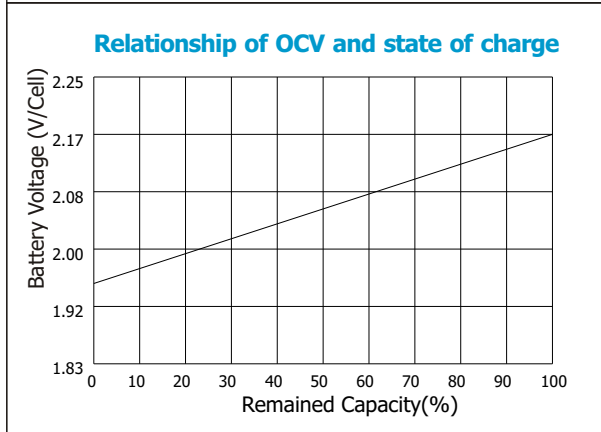
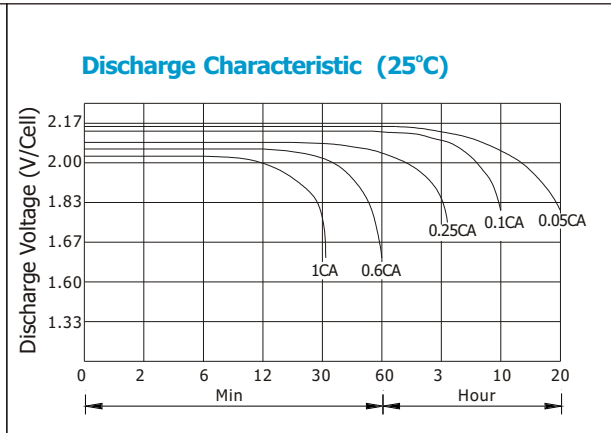
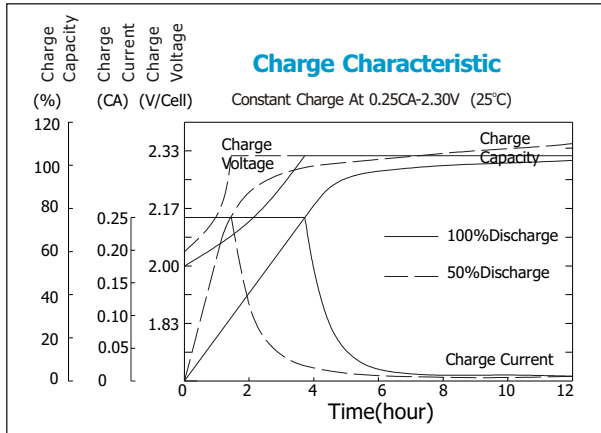

Constant current discharge ratings-amperes at 25°C

TIME	1HR	3HR	5HR	10HR	24HR	48HR	72HR	96HR	120HR	240HR
CUT-OFF VOLTAGE	1.67	1.75	1.77	1.80	1.85	1.85	1.85	1.85	1.85	1.85
CAPACITY(AH)	930	1395	1575	1875	2250	2512	2625	2630	2640	2715

Constant power discharge ratings-watts at 25°C

TIME	1HR	3HR	5HR	10HR	24HR	48HR	72HR	96HR	120HR	240HR
CUT-OFF VOLTAGE	1.67	1.75	1.77	1.80	1.85	1.85	1.85	1.85	1.85	1.85
CAPACITY(WH)	1228	2358	2615	2981	3285	3668	3833	3840	3854	3964

